



# DATASHEET

SCREWDRIVER

v1.1











# 1. Datasheet

## 1.1. Screwdriver

General Properties		Minimum	Typical	Maximum	Unit
Torque range		0.15 0.11	-	5 3.68	[Nm] [lbft]
Torque accuracy*	If torque < 1.33 Nm/ 0.98 lbft	-	0.04 0.03	-	[Nm] [lbft]
	If torque > 1.33 Nm/ 0.98 lbft	-	3	-	[%]
Output speed		-	-	340	[RPM]
Screw length within full safety		-	-	35 1.37	[mm] [inch]
Shank stroke (screw axis)		-	-	55 2.16	[mm] [inch]
Shank preload (adjustable)		0	10	25	[N]
Safety feature force		35	40	45	[N]
Storage temperature		0 32	- -	60 140	[°C] [°F]
Motor (x2)		Integrated, electric BLDC			
IP Classification		IP54			
ESD Safe		Yes			
Dimensions		308 x 86 x 114 12.1 x 3.4 x 4.5			[mm] [inch]
Weight		2.5 5.51			[kg] [lb]

\* See [Torque Accuracy Graph](#) for further information.

Operating Conditions	Minimum	Typical	Maximum	Unit
Power supply	20	24	25	[V]
Current consumption	75	-	4500	[mA]
Operating temperature	5	-	50	[°C]
	41	-	122	[°F]
Relative humidity (non-condensing)	0	-	95	[%]
Calculated MTBF (operating life)	30.000	-	-	[Hours]

Supported Screws Metric						
Material type		Magnetic				
Screw length		Up to 50 mm (35 mm thread length)				
Head type		Cylinder			Counter sunk	Button head
Appearance						
Standard		Din 912 / ISO 4762 	ISO 14579 	ISO 14580 	ISO 14581 	DIN 7985A 
Supported Thread Size	M1.6	✓	N/A	N/A	N/A	N/A
	M2	✓	✓	N/A	✓	✓
	M2.5	✓	✓	N/A	✓	✓
	M3	✓	✓	✓	✓	✓
	M4	✓	✓	✓	✓	✓
	M5	✓	✓	✓	✓	✓
	M6	✓	✓	✓	✓	✓

Supported Screws US Standard			
Material type		Magnetic	
Screw length		Up to 1.96 inches (1.37 inches thread length)	
Head type		Cylinder	Button head
		Counter sunk	

Supported Screws US Standard						
Appearance						
Standard		ASME B18.3	ASME B18.6.3	ASME B18.6.3	ASME B18.3	ASME B18.6.3
Supported Thread Size	1#	✓	N/A	N/A	N/A	N/A
	2#	✓	✓	✓	N/A	✓
	4#	✓	✓	✓	✓	✓
	6#	✓	✓	✓	✓	✓
	8#	✓	✓	✓	✓	✓
	10#	✓	✓	✓	✓	✓
	12#	N/A	✓	✓	N/A	N/A
	1/4"	✓	N/A	N/A	✓	N/A

### Torque accuracy Metric

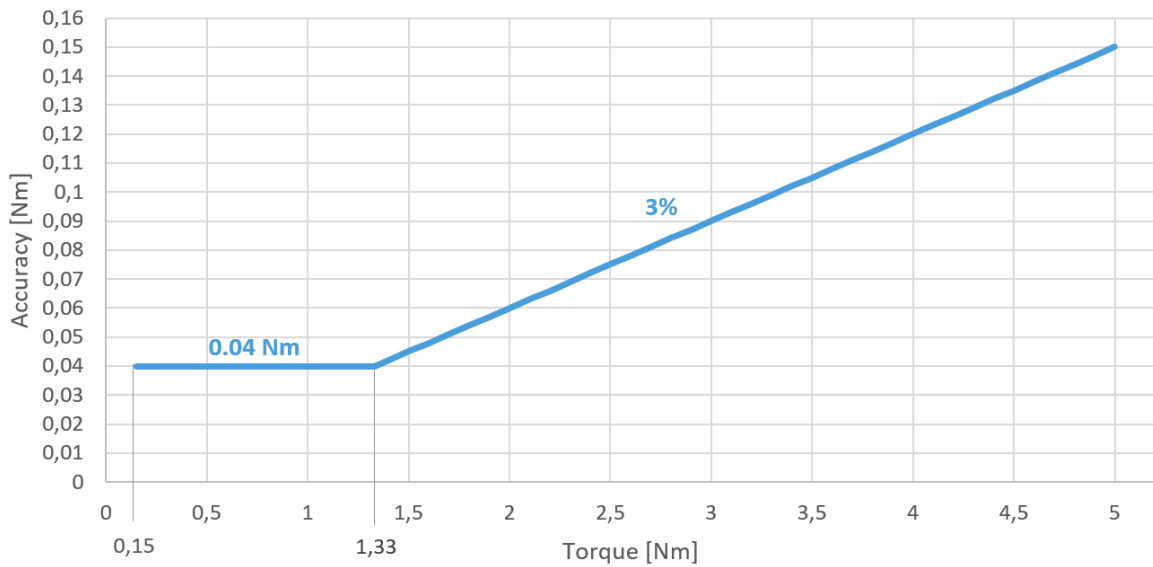

### Torque accuracy US Standard

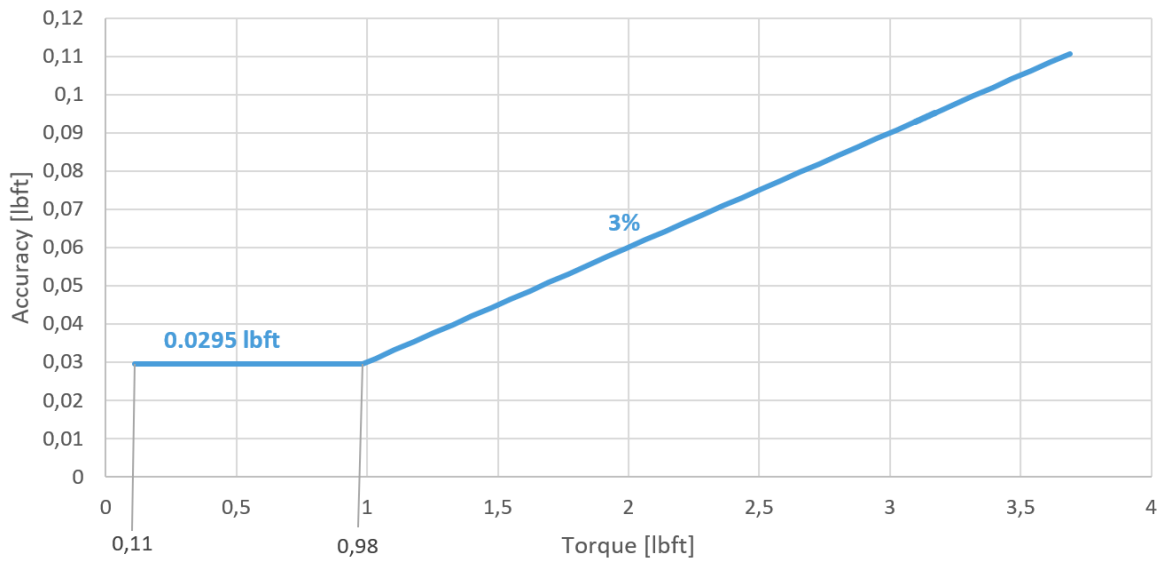

### Screw-bit System

This system will highly increase the efficacy of the screws to be picked up, aligned with the bit, moved around with the Screwdriver and screwed in/out. Therefore, it is highly recommended to set up the Screw-bit System correctly to keep a high success rate.

Example of the Screw-bit System for an ISO 14579 screw.

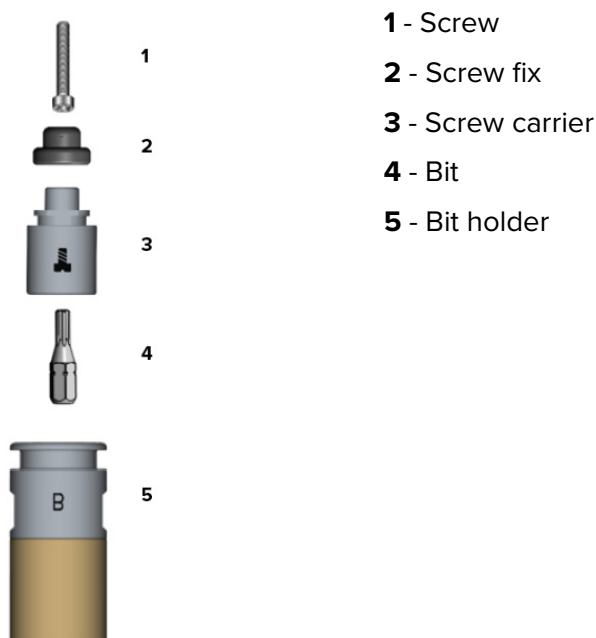

The sections below explain the different components of the Screw-bit System and how to set it up correctly.

In the following tables, an overview of the items needed depending on the Screw type and size are shown.











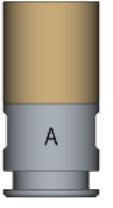

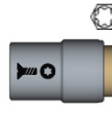
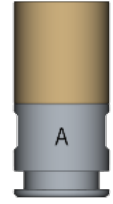

**Items Needed Depending on Screw Type and Size for Metric Screws**

Items Needed Depending on Screw Type and Size for Metric Screws					
Head type	Cylinder			Counter sunk	Button head
Screw standard	Din 912 / ISO 4762	ISO 14579	ISO 14580	ISO 14581	DIN 7985A
Thread Size	Bit holder, bit, screw carrier and screw fix needed				
M1.6	<p>⊙ S1.5 M1.6 M1.6 B</p>	N/A	N/A	N/A	N/A
M2	<p>⊙ S1.5 M2 M2-3 A</p>	<p>⊙ T6 M2 M2-3 A</p>	N/A	<p>⊙ T6 M2 B</p>	<p>⊙ PH1 M2 B</p>
M2.5	<p>⊙ S2 M2.5 M2-3 A</p>	<p>⊙ T8 M2.5 M2-3 A</p>	N/A	<p>⊙ T8 M2.5 B</p>	<p>⊙ PH1 M2.5 B</p>
M3	<p>⊙ S2.5 M3 M2-3 A</p>	<p>⊙ T10 M3 M2-3 A</p>	<p>⊙ T10 M3 M2-3 A</p>	<p>⊙ T10 M3 A</p>	<p>⊙ PH1 M3 A</p>
M4	<p>⊙ S3 M4 M4-6 A</p>	<p>⊙ T20 M4 M4-6 A</p>	<p>⊙ T20 M4 M4-6 A</p>	<p>⊙ T20 M4 A</p>	<p>⊙ PH2 M4 A</p>
M5	<p>⊙ S4 M5 M4-6 A</p>	<p>⊙ T25 M5 M4-6 A</p>	<p>⊙ T25 M5 M4-6 A</p>	<p>⊙ T25 M5 A</p>	<p>⊙ PH2 M5 A</p>

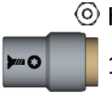
Items Needed Depending on Screw Type and Size for Metric Screws					
M6	S5 M6 M4-6 A	T30 M6 M4-6 A	T30 M6 M4-6 A	T30 M6 A	PH3 M6 A

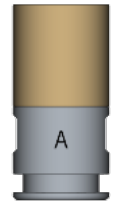
Items Needed Depending on Screw Type and Size for US Standard Screws

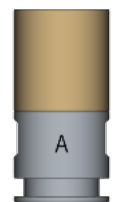
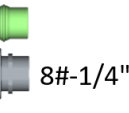
Items Needed Depending on Screw Type and Size for US Standard Screws					
Head type	Cylinder	Button head		Counter sunk	
Screw standard	ASME B18.3	ASME B18.6.3	ASME B18.6.3	ASME B18.3	ASME B18.6.3
	HEX	Cross recessed	Torx	HEX	Torx
Thread Size	Bit holder, bit, screw carrier and screw fix needed				
1#	H1/16" 1#	N/A	N/A	N/A	N/A
2#	H5/64" 2#-6#	PH1 2#	T8 2#	N/A	T6 2#
4#	H3/32" 2#-6#	PH1 4#	T10 4#	H1/16" 4#	T8 4#
6#	H7/64" 2#-6#	PH1 6#	T15 6#	H5/64" 6#	T10 6#

Items Needed Depending on Screw Type and Size for US Standard Screws					
 8#	 H9/64" 8#-1/4"	 PH2 8#	 T20 8#	 H3/32" 8#	 T15 8#
 10#	 H5/32" 8#-1/4"	 PH2 10#	 T25 10#	 H1/8" 10#	 T20 10#
 12#	N/A	 PH3 12#	 T27 12#	N/A	N/A
 1/4"	 H3/16" 8#-1/4"	N/A	N/A	 T30 1/4"	N/A

### 1. Screws

The first step is to know what type of screw is going to be used. The screw type will define what type of bit, screw carrier, screw fix (if any) and bit holder shall be used.

The recommended screw types for the Screwdriver are the ones that have the properties mentioned previously on the [Supported Screws](#) table.

### 2. Bit Holder

Select the right bit holder depending on the screw type and size to maximize the efficacy of the Screw-bit System based on the table in section [Items Needed Depending on Screw Type and Size for Metric](#) or [Items Needed Depending on Screw Type and Size for US Standard Screws](#).

The Bit holder generates a magnetic force that will keep the screw attached and aligned to the bit. The Bit holder **A** generates a higher magnetic force than **B**. Therefore, the bit holder B is commonly used for the smaller and lighter screws.

### 3. Bits

Select the right bit depending on the screw type and size to maximize the efficacy of the Screw-bit System based on the table in section [Items Needed Depending on Screw Type](#)



**and Size for Metric or Items Needed Depending on Screw Type and Size for US Standard Screws.**

The bits have signifiers to help identifying what bit type and size these are.

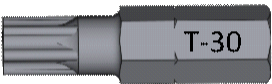
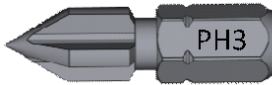
Screw type standard	Shows bit size and type
Din 912 / ISO 4762 ASME B18.3 HEX Cylinder	
ISO 14579 ISO 14580 ISO 14581 ASME B18.6.3 Torx Button head ASME B18.6.3 Torx Counter sunk	
DIN 7985A ASME B18.6.3 Cross recessed Button head	

Supported bit shank properties:

- Type 1/4" HEX
- Length 25 mm





**NOTE:**

Bits longer than 25 mm could be used. However, the screw carrier and the screw fix might not hold the screw properly in place.

**4. Screw Carrier and Screw Fix**

Select the right screw carrier and screw fix depending on the screw type and the size to maximize the efficacy of the Screw-bit System based on the table on section Items needed depending on Screw type and size.

The screw carriers have signifiers to help identifying what screw type and size these can be used with.

Screw thread size	Screw type illustration
	

The screw fixes are only needed for the Din 912, ISO 4762, ISO 14579, ISO 14580 and ASME B18.3 HEX Cylinder screw types. The screw fixes also have signifiers to show what size of screw they support.





Screw fixes for Metric - Din 912, ISO 4762, ISO 14579, ISO 14580						
M1.6	M2	M2.5	M3	M4	M5	M6

Screw fixes for US Standard - ASME B18.3 HEX Cylinder						
1#	2#	4#	6#	8#	10#	1/4"

All screw carries must be adjusted to ensure high performance of the Screw-bit System.





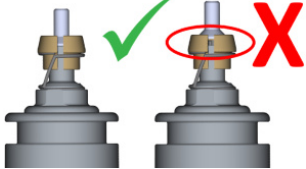
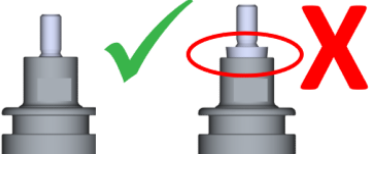

Appearance	Adjustment method

The screw carries must be adjusted so that the screw head seats stable on the screw carrier avoiding a gap in between. See the pictures below as reference.

<p>Din 912 / ISO 4762 / ISO 14579 / ISO 14580 / ASME B18.3 Hex Cylinder</p>		<p>ISO 14581 / ASME B18.6 HEX Counter sunk / ASME B18.6.3 Torx Counter sunk</p>		<p>DIN 7985A / ASME B18.6.3 Cross recessed Button head / ASME B18.6.3 Torx Button head</p>	
					

When this is achieved, remove the screw and push in the screw fix (only Din 912, ISO 4762, ISO 14579, ISO 14580 and ASME B18.3 HEX Cylinder screw types).

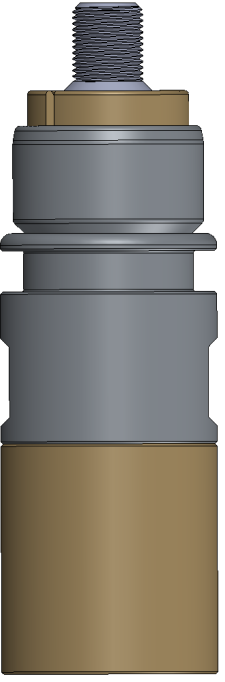
The final setup of the Screw-bit System with the screw in place should look like picture below.

Screw standard	Din 912 / ISO 4762 / ISO 14579 / ISO 14580 / ASME B18.3 Hex Cylinder		ISO 14581 / ASME B18.6 HEX Counter sunk / ASME B18.6.3 Torx Counter sunk		DIN 7985A / ASME B18.6.3 Cross recessed Button head / ASME B18.6.3 Torx Button head	
Screw-bit System appearance						

### 5. Attaching and Detaching the Screw-bit System to/from the Screwdriver

The last step is to attach the system to the Screwdriver by placing the hex shape of the bit holder inside of the end of the screwdriver's shank as shown in the picture below. The system will be attached to the screwdriver by a magnetic force.

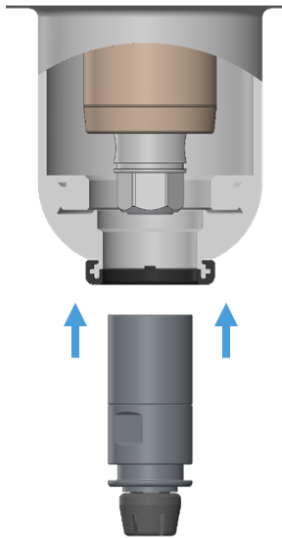

To remove the Bit holder from the screwdriver's shank, follow the steps below:

1. Move the shank all the way out to position 55 by operating the user interface in the robot or in the Web Client.
2. As shown in the images below, use the provided key to grab the Bit holder.
3. While holding the key, move the shank inwards by operating the user interface in the robot or in the Web Client.

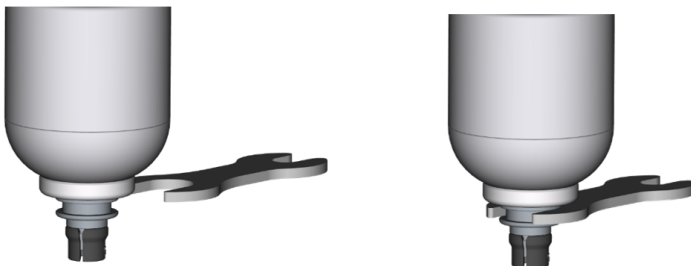

### Screwdriver Position to Execute Commands

To successfully execute the screwdriver commands, it is fundamental to position the screwdriver correctly. This is achieved if the following two conditions are met:

1. The Screw-bit System must be perfectly aligned to the screw or thread.

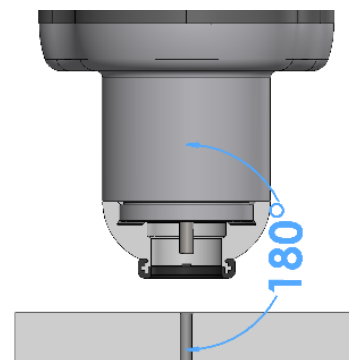

- The distance between the Screwdriver's bottom part and the surface where the action takes place must be within the range of 0-8 mm [0-0.31 inches].

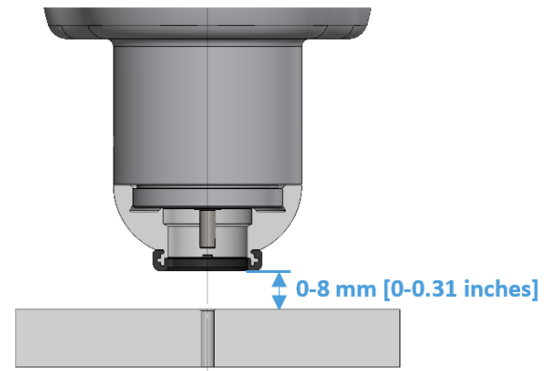

### LED - Device Status

The screwdriver has a LED that shows the device status.

Color	Device Status
No light	Power missing
Steady green	Ready to work - Idle - Static
Blinking green	Initializing
Steady orange	Busy – Moving/rotating shank
Blinking orange	Operational malfunction
Steady red	Not working – Hardware problem
Blinking red	Safety – Emergency stop

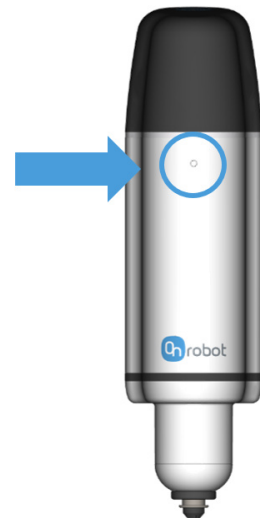

### Torque Angle Curve and Torque Gradient

The torque gradient shows how the torque is applied in the last phase of the Tightening screw command. This could be used as an indicator to detect if a Tightening command is performed correctly.

For instance, the torque gradient could be different if:

- The hole thread is not long enough

- The hole thread is different from the screw thread
- The hole thread is not clean (for instance by deburrs from CNC machining)
- The friction between the screw thread and the hole thread is too low or too high
- The friction between the screw head and the tighten part is too low or too high

A torque gradient variable is made available to be checked in the robot program.

The graph below shows a normal Torque/Angle curve. In this case has been made with a M4 screw and 2.4 Nm as target torque.

**Torque angle curve Metric**

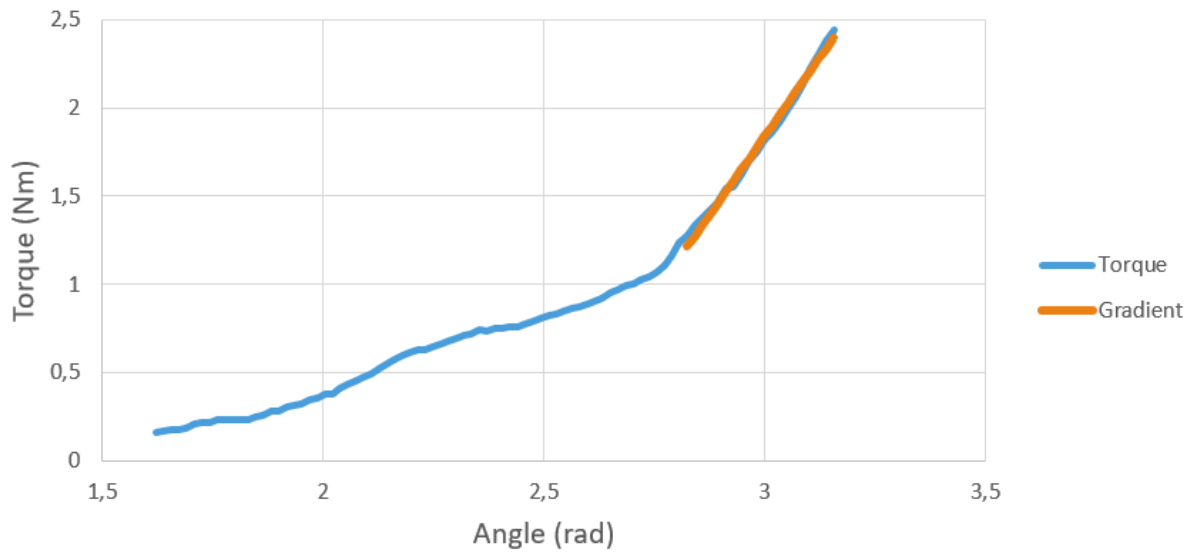

**Torque angle curve US Standard**

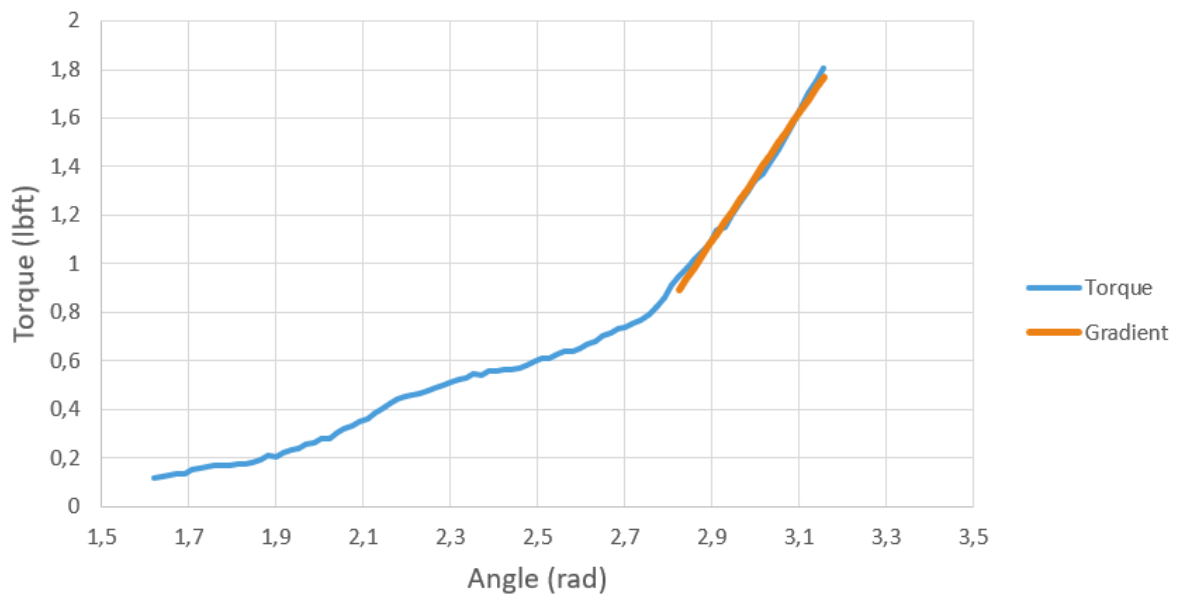

## 1.2. Screwdriver

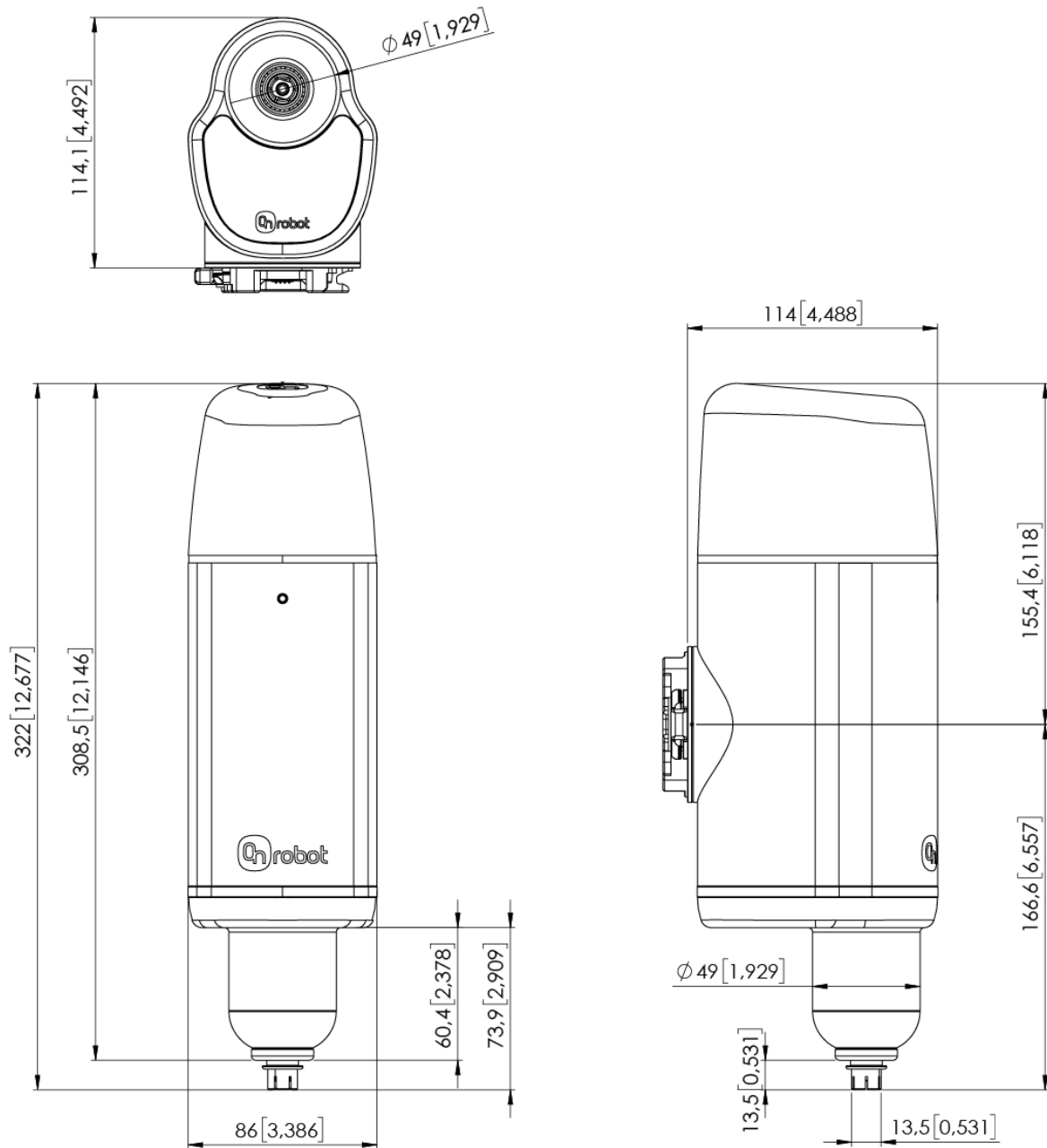

All dimensions are in mm and [inches].