

Pussisakkelit kierretapilla G-209

Sakkeleiden kantavuudet 0,3 - 55 tonnia. Kaari hiiliterästä C1035, tappi seosterästä A4130. Jokaiseen sakkeliin on merkitty valmistaja, SSK, tehdas, valmistuserä, raaka-aine ja pikatarkastusmerkinnät. Sakkelit on testattu 2-kertaisella kuormalla ja niissä on 5-kertainen varmuus. Sakkelit on galvanoitu. Ne ovat pienikokoisia ja kevyitä, mikä johtuu hyvästä raaka-aineesta.

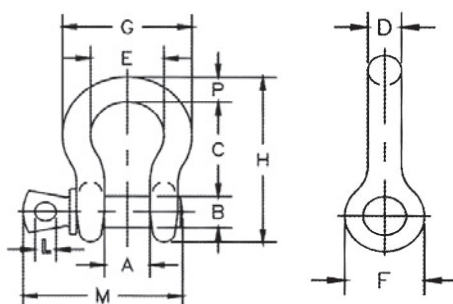

G-209 pussisakkelit, kierretapilla

Tuotenumero	Nimelliskoko (")	SSK t	Paino kg	Mitat mm													Toler. +/-	
				A	B	C	D	E	F	G	H	L	M	P	C	A		
1018357	3/16	0,33	0,03	9.65	6.35	22.4	4.85	15.2	14.2	24.9	37.3	4.06	28.4	4.85	1.50	1.50		
1018375	1/4	0,5	0,05	11.9	7.85	28.7	6.35	19.8	15.5	32.5	46.7	4.85	35.1	6.35	1.50	1.50		
1018393	5/16	0,75	0,09	13.5	9.65	31.0	7.85	21.3	19.1	37.3	53.0	5.60	42.2	7.85	3.30	1.50		
1018419	3/8	1	0,14	16.8	11.2	36.6	9.65	26.2	23.1	45.2	63.0	6.35	51.5	9.65	3.30	1.50		
1018437	7/16	1,5	0,17	19.1	12.7	42.9	11.2	29.5	26.9	51.5	74.0	7.85	60.5	11.2	3.30	1.50		
1018455	1/2	2	0,33	20.6	16.0	47.8	12.7	33.3	30.2	58.5	83.5	9.65	68.5	12.7	3.30	1.50		
1018473	5/8	3,25	0,62	26.9	19.1	60.5	16.0	42.9	38.1	74.5	106	11.2	85.0	17.5	6.35	1.50		
1018491	3/4	4,75	1,07	31.8	22.4	71.5	19.1	51.0	46.0	89.0	126	12.7	101	20.6	6.35	1.50		
1018516	7/8	6,5	1,64	36.6	25.4	84.0	22.4	58.0	53.0	102	148	12.7	114	24.6	6.35	1.50		
1018534	1	8,5	2,28	42.9	28.7	95.5	25.4	68.5	60.5	119	167	14.2	129	26.9	6.35	1.50		
1018552	1-1/8	9,5	3,36	46.0	31.8	108	29.5	74.0	68.5	131	190	16.0	142	31.8	6.35	1.50		
1018570	1-1/4	12	4,31	51.5	35.1	119	32.8	82.5	76.0	146	210	17.5	156	35.1	6.35	1.50		
1018598	1-3/8	13,5	6,14	57.0	38.1	133	36.1	92.0	84.0	162	233	19.1	174	38.1	6.35	3.30		
1018614	1-1/2	17	7,80	60.5	41.4	146	39.1	98.5	92.0	175	254	20.6	187	41.1	6.35	3.30		
1018632	1-3/4	25	12,6	73.0	51.0	178	46.7	127	106	225	313	25.4	231	57.0	6.35	3.30		
1018650	2	35	20,4	82.5	57.0	197	53.0	146	122	253	348	31.0	263	61.0	6.35	3.30		
1018678	2-1/2	55	38,9	105	70.0	267	69.0	184	145	327	453	35.1	330	79.5	6.35	6.35		

Suorasakkeli kierretapilla G-210

Sakkeleiden kantavuudet 0,3 - 55 tonnia. Kaari hiiliterästä C1035, tappi seosterästä A4130. Sakkelit on testattu 2-kertaisella kuormalla ja niissä on 5-kertainen varmuus. Sakkelit on galvanoitu. Ne ovat pienikokoisia ja kevyitä, mikä johtuu hyvästä raaka-aineesta.

Tuotenumero G-210	Nimellis- koko (")	SSK t	Paino kg	Mitat mm										Toler. +/-	
				A	B	C	D	E	F	G	K	L	M	C	A
1019150	1/4	0,5	0.05	11.9	7.85	6.35	6.35	24.6	15.5	22.4	40.4	4.85	35.1	1.50	1.50
1019178	5/16	0,75	0.08	13.5	9.65	7.85	7.85	29.5	19.1	26.2	48.5	5.60	42.2	1.50	1.50
1019196	3/8	1	0.13	16.8	11.2	9.65	9.65	35.8	23.1	31.8	58.5	6.35	51.5	3.30	1.50
1019212	7/16	1,5	0.20	19.1	12.7	11.2	11.2	41.4	26.9	36.6	67.5	7.85	60.5	3.30	1.50
1019230	1/2	2	0.27	20.6	16.0	12.7	12.7	46.0	30.2	41.4	77.0	9.65	68.5	3.30	1.50
1019258	5/8	3,25	0.57	26.9	19.1	15.7	16.0	58.5	38.1	51.0	95.5	11.2	85.0	3.30	1.50
1019276	3/4	4,75	1.20	31.8	22.4	20.6	19.1	70.0	46.0	60.5	115	12.7	101	6.35	1.50
1019294	7/8	6,5	1.43	36.6	25.4	24.6	22.4	81.0	53.0	71.5	135	12.7	114	6.35	1.50
1019310	1	8,5	2.15	42.9	28.7	25.4	25.4	93.5	60.5	81.0	151	14.2	129	6.35	1.50
1019338	1-1/8	9,5	3.06	46.0	31.8	31.8	28.7	103	68.5	91.0	172	16.0	142	6.35	1.50
1019356	1-1/4	12	4.11	51.5	35.1	35.1	31.8	115	76.0	100	191	17.5	156	6.35	3.30
1019374	1-3/8	13,5	5.28	57.0	38.1	38.1	35.1	127	84.0	111	210	19.1	174	6.35	3.30
1019392	1-1/2	17	7.23	60.5	41.4	41.1	38.1	137	92.0	122	230	20.6	187	6.35	3.30
1019418	1-3/4	25	12.1	73.0	51.0	54.0	44.5	162	106	146	279	25.4	231	6.35	3.30
1019436	2	35	19.2	82.5	57.0	51.0	51.0	184	122	172	312	31.0	263	6.35	3.30
1019454	2-1/2	55	32.5	105	70.0	66.5	66.5	238	145	203	377	35.1	330	6.35	6.35

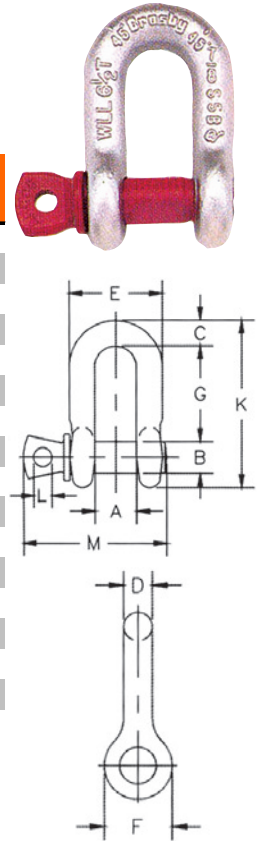

Pussisakkeli mutterilla ja lukitussokalla G-2130

Sakkeleiden kantavuudet 2 - 150 tonnia. Kaari hiiliterästä C1035, tappi seosterästä A4130. Koot 2 - 55 tonnia heti varastosta. Koot 85 - 150 tonnia tehdastoimituksena. Sakkelit on testattu 2-kertaisella kuormalla ja niissä on 5-kertainen varmuus. Sakkelit on galvanoitu. Ne ovat pienikokoisia ja kevyitä, mikä johtuu hyvästä raaka-aineesta.

Tuotenumero G - 2130	Nimellis- koko (")	SKK t	Paino kg	Mitat mm										Toler. +/-	
				A	B	C	D	E	F	H	L	N	C	A	
†1019464	3/16	0,33	0.03	9.65	6.35	22.4	4.85	15.2	14.2	37.3	24.9	4.85	1.50	1.50	
1019466	1/4	0,5	0.05	11.9	7.85	28.7	6.35	19.8	15.5	46.7	32.5	6.35	1.50	1.50	
1019468	5/16	0,75	0.10	13.5	9.65	31.0	7.85	21.3	19.1	53.0	37.3	7.85	3.30	1.50	
1019470	3/8	1	0.15	16.8	11.2	36.6	9.65	26.2	23.1	63.0	45.2	9.65	3.30	1.50	
1019471	7/16	1,5	0.22	19.1	12.7	42.9	11.2	29.5	26.9	74.0	51.5	11.2	3.30	1.50	
1019472	1/2	2	0.36	20.6	16.0	47.8	12.7	33.3	30.2	83.5	58.5	12.7	3.30	1.50	
1019490	5/8	3,25	0.76	26.9	19.1	60.5	16.0	42.9	38.1	106	74.5	17.5	6.35	1.50	
1019515	3/4	4,75	1.23	31.8	22.4	71.5	19.1	51.0	46.0	126	89.0	20.6	6.35	1.50	
1019533	7/8	6,5	1.79	36.6	25.4	84.0	22.4	58.0	53.0	148	102	24.6	6.35	1.50	
1019551	1	8,5	2.57	42.9	28.7	95.5	25.4	68.5	60.5	167	119	26.9	6.35	1.50	
1019579	1-1/8	9,5	3.75	46.0	31.8	108	28.7	74.0	68.5	190	131	31.8	6.35	1.50	
1019597	1-1/4	12	5.31	51.5	35.1	119	31.8	82.5	76.0	210	146	35.1	6.35	1.50	
1019613	1-3/8	13,5	7.18	57.0	38.1	133	35.1	92.0	84.0	233	162	38.1	6.35	3.30	
1019631	1-1/2	17	9.43	60.5	41.4	146	38.1	98.5	92.0	254	175	41.1	6.35	3.30	
1019659	1-3/4	25	15.4	73.0	51.0	178	44.5	127	106	313	225	57.0	6.35	3.30	
1019677	2	35	23.7	82.5	57.0	197	51.0	146	122	348	253	61.0	6.35	3.30	
1019695	2-1/2	55	44.6	105	70.0	267	66.5	184	145	453	327	79.5	6.35	6.35	
1019711	3	†85	-70	127	82.5	330	76.0	200	165	546	365	92.0	6.35	6.35	
1019739	3-1/2	†120†	-120	133	95.5	372	92.0	229	203	626	419	105	6.35	6.35	
1019757	4	†150†	-153	140	108	368	104	254	229	653	468	116	6.35	6.35	

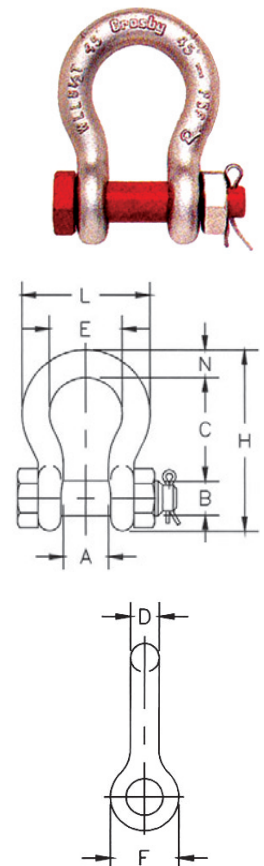

† yksittäistestattu, ‡ pyöreäkantainen ruuvi kädensijoilla varustettuna

G-210 ja G-2130 -sakkeleihin on merkitty valmistaja, SSK, tehdas, valmistuserä, raaka-aine ja pikatarkastusmerkinnät.

Huom! G-209 ja G-2130 -sakkelit ovat DNV-todistuksen 2.7-1 -vaatimusten mukaisia ja soveltuvat avomerikäyttöön.

Suorasakkeli mutterilla ja lukitussokalla G-2150

Kantavuudet 0,5 - 85 tonnia. Kaari hiiliterästä C1035, tappi seosterästä A4130. Sakkelit on testattu 2-kertaisella kuormalla ja niissä on 5-kertainen varmuus. Sakkelit on galvanoitu. Ne ovat pienikokoisia ja kevyitä, mikä johtuu hyvästä raaka-aineesta.

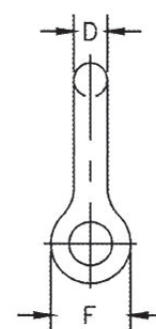
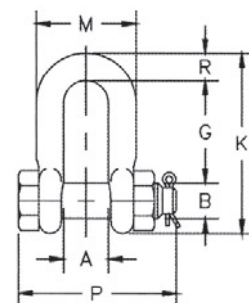

Tuotenro	Nimellis- koko (")	SSK Paino		Mitat mm										Toler.+/-	
		t	kg	A	B	D	F	G	K	M	P	R	C	A	
1019768	1/4	0,5	0.06	11.9	7.85	6.35	15.5	19.1	40.4	24.6	39.6	6.35	1.50	1.50	
1019770	5/16	0,75	0.10	13.5	9.65	7.85	19.1	25.4	48.5	29.5	46.2	7.85	1.50	1.50	
1019772	3/8	1	0.15	16.8	11.2	9.65	23.1	31.0	58.5	35.8	55.0	9.65	3.30	1.50	
1019774	7/16	1,5	0.22	19.1	12.7	11.2	26.9	36.1	67.5	41.1	63.5	11.2	3.30	1.50	
1019775	1/2	2	0.34	20.6	16.0	12.7	30.2	41.4	77.0	46.0	71.0	12.7	3.30	1.50	
1019793	5/8	3,25	0.67	26.9	19.1	16.0	38.1	51.0	95.5	58.5	89.5	16.0	3.30	1.50	
1019819	3/4	4,75	1.14	31.8	22.4	19.1	46.0	60.5	115	70.0	103	20.6	6.35	1.50	
1019837	7/8	6,5	1.74	36.6	25.4	22.4	53.0	71.5	135	81.0	120	24.6	6.35	1.50	
1019855	1	8,5	2.52	42.9	28.7	25.4	60.5	81.0	151	93.5	135	25.4	6.35	1.50	
1019873	1-1/8	9,5	3.45	46.0	31.8	28.7	68.5	91.0	172	103	150	31.8	6.35	1.50	
1019891	1-1/4	12	4.90	51.5	35.1	31.8	76.0	100	191	115	165	35.1	6.35	1.50	
1019917	1-3/8	13,5	6.24	57.0	38.1	35.1	84.0	111	210	127	183	38.1	6.35	3.30	
1019935	1-1/2	17	8.39	60.5	41.4	38.1	92.0	122	230	137	196	41.4	6.35	3.30	
1019953	1-3/4	25	14.2	73.0	51.0	44.5	106	146	279	162	230	54.0	6.35	3.30	
1019971	2	35	21.2	82.5	57.0	51.0	122	172	312	184	264	51.0	6.35	3.30	
1019999	2-1/2	55	38.6	105	70.0	66.5	145	203	377	238	344	66.5	6.35	6.35	
1020013	3	†85	56	127	82.5	76.0	165	216	429	279	419	89.0	6.35	6.35	

Leveärunkoinen pussisakkeli mutterilla ja lukitussokalla G-2160

Kantavuudet 30 - 1000 tonnia. Laajennettu kaari lisää köyden kosketuspinta-alaa 58 % ja lujuutta 15 %. Parantaa huomattavasti nosteraksien kulumiskestävyyttä. Kaussien käyttö ei ole välttämätöntä. Sakkelit on galvanoitu, tapit maalattu.

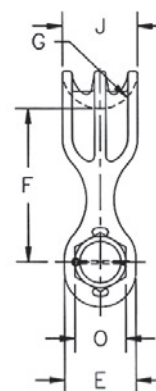
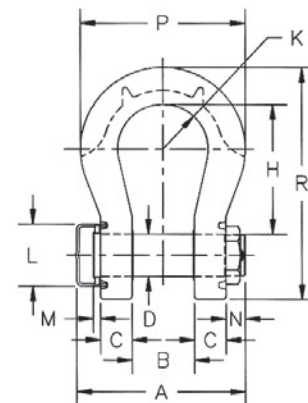

Tuotenro	SSK * Paino		Mitat mm											
	t	kg	A	B ¹⁾	C	D ²⁾	E	G	H	J	K	P	R	
1021575	†30	11.3	197	60.5	35.1	41.4	90.4	51.0	165	79.5	63.5	232	279	
1021584	†40	15.9	230	73.2	44.5	51.0	102	58.7	205	95.3	76.2	270	346	
1021593	†55	32.2	264	82.5	51.0	57.4	118	66.8	238	114	88.9	327	394	
1021290	†75	45	346	105	54.0	70.0	121	64.0	290	120	92.5	313	465	
1021307	†125	73	400	130	65.0	80.0	145	80.0	365	150	110	380	576	
1021316	†200	227	508	150	85.0	105	185	110	480	205	137	495	757	
1021325	†300	368	591	185	102	133	235	140	600	265	160	601	950	
1021334	††400	472	715	220	131	160	280	160	575	320	185	690	985	
1021343	††500	625	809	250	142	180	318	170	630	340	225	790	1085	
1021352	††600	831	913	275	153	200	350	185	700	370	247	865	1200	
1021361	††700	1109	992	300	167	215	376	200	735	400	270	940	1275	
1021254	††800	1368	986	325	183	230	400	210	750	420	277	975	1323	
1021389	††900	1559	1050	350	198	250	430	220	757	440	293	1025	1373	
1021370	††1000	1824	1176	380	212	270	450	230	760	460	308	1075	1405	

B¹⁾ +/- 6.35, D²⁾ +/- 0.5

* Varmuuskerroin 5 SSK:n nähden

† Taottu seosteräs, koekuormitus 2 x SSK, †† Valettu terässeos, koekuormitus 1,33 x SSK

Huom: Kaikki G-2160-sakkelit on magneettijauhetarkastettu.

G-2150 ja G-2160 -sakkeleihin on merkitty valmistaja, SSK, tehdas, valmistuserä, raaka-aine ja pikatarkastusmerkinnät.

Pussisakkeli mutterilla ja lukitussokalla G-2140

Kantavuudet 30 - 400 tonnia. Jokaiseen sakkeliin on merkitty valmistaja, SSK, tehdas, valmistuserä, raaka-aine ja pikatarkastusmerkinnät. Sakkeleissa on 4- tai 5-kertainen varmuus, ks. huomautus. Sakkelit on galvanoitu. Sakkelit ovat kooltaan suhteellisen pienikokoisia, mikä johtuu hyvästä raaka-aineesta.

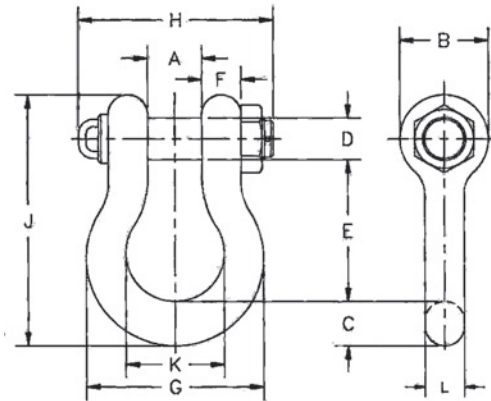

Tuotenro	Nimellis- koko (")	SSK *	Paino kg	Mitat mm											Toleranssi +/-	
				A	B	C	D	E	F	G	H	J	K	L	A	E
1021110	1-1/2	30	9.43	60.5	92.0	41.1	41.4	146	35.3	175	197	254	98.5	39.1	3.30	6.35
1021138	1-3/4	40	15.4	73.0	106	57.0	51.0	178	44.5	225	230	313	127	46.7	3.30	6.35
1021156	2	55	23.6	82.5	122	61.0	57.0	197	51.0	253	264	348	146	53.0	3.30	6.35
1021174	2-1/2	85	43.5	105	145	79.0	70.0	267	66.5	327	344	453	184	69.0	6.35	6.35
1021192	3	120	81	127	165	92.0	82.5	330	76.0	365	419	546	200	79.0	6.35	6.35
1021218	3-1/2†	150	120	133	203	105	95.5	372	95.5	419	483	625	229	92.0	6.35	6.35
1021236	4†	175	153	140	229	116	108	368	102	468	502	626	254	104	6.35	6.35
1021414	4-3/4**†	200	204	184	267	152	121	397	95.5	533	521	743	279	114	6.35	6.35
1021432	5**†	250	272	216	305	165	127	508	98.5	622	558	889	330	114	6.35	6.35
1021450	6**†	300	352	213	305	172	152	495	121	635	618	895	330	127	6.35	6.35
1021478	7**†	400	500	210	356	184	178	572	165	660	710	1022	330	152	6.35	6.35

* Maksimi koekuormitus 2 x SSK

** Valettu seosteräs

Kokoluokissa 200 - 400 tonnia varmuuskerroin vähintään 4.

Kokoluokissa 30 - 175 tonnia varmuuskerroin 5,4.

† Sakkelin tappi on varustettu hitsatulla käsikahvalla.